



TABLE OF CONTENTS

1 - PRESENTATION, SAFETY RECOMMENDATIONS AND GENERAL PRECAUTIONS	2
2 - DESCRIPTION	3
- Front panel	3
- Rear panel	3
- Clamps	3
3 - INSTALLATION	4
4 -EQUIPMENT OPERATION	5
- Key definition	5
- Use of the C clamp	6-7
- Use of the X clamp	8-9
- Use of the single sided gun	10
- Error management	11
- Welding spots counter	12
- Recording features (identification mode – user’s parameters)	13-14
- SD memory card	15
- GYSPOT software on PC	15-16
5 - PRECAUTIONS AND SERVICING	17
- Relacement of caps/electrodes	17
- Cleaning or replacement of welding tools	17
- purge of th epneumatic filter	17
- maintenance of the generator	17
- Replacement and adjustment of X arms	18
- Replacement and adjustment of C arms	19
6 – ASSEMBLY INSTRUCTIONS	20-21
7 – TECHNICAL CHARACTERISTICS	22
8 - ANOMALIES / CAUSES / REMEDIES	23
9 - ICONS	24
10 – DECLARATION OF CONFORMITY	24
11 – WARRANTY	25
12 – CIRCUIT DIAGRAM	26-27



Autres langues disponibles sur la carte SD.
Other languages available on the SD card.
Weitere auf SD-Karte verfügbare Sprachen.

Thank you for your purchase! Before installing and using the product or before maintenance, please read the following safety recommendations to avoid accidents and damage.

GYS cannot be held responsible for damages to persons or belongings following the use of the machine in the following circumstances:

- Modification or disabling of safety elements,
- Non-respect of the recommendations written in the user manual,
- Modification of the characteristics of the product,
- Use of accessories other than the GYS accessories, or accessories not adapted to the machine
- Non-respect of the regulations and particular dispositions in the country where the machine is installed.

1- PRESENTATION, SAFETY RECOMMENDATIONS AND GENERAL PRECAUTIONS

This product has been designed to carry out the following operations in car body workshops:

- Spot welding on metal sheets with a pneumatic clamp,
- Welding of metal sheets with a single sided gun,
- Welding of nails, rivets, washers and studs,
- Repair of bumps and impacts (impacts of hail with the option « quick repair”).

GENERALITIES

1. The operators must have completed appropriate training.
2. The repair and maintenance operations can only be performed by qualified personnel.
3. The operator is responsible for observing the car manufacturer's recommendations, regarding the protection of the car electrical and electronic equipments (car computer, car radio, alarm, air bag, etc...).
4. Before any repair or maintenance operation, the compressed air supply must be disconnected and depressurized.
5. The electrodes, arms, as well as the other secondary conductors can reach a very high temperature and remain hot long after having stopped the machine. Pay particular attention to the risks of serious burns.
6. It is necessary to make a regular preventive maintenance on the machine.

MAINS SUPPLY

1. Check whether the unit is correctly connected to the earth and that the connection to the earth is in good condition.
2. Check whether the workbench is connected to the earth coupler.
3. Make sure that the operator has no contact with the metal parts to be welded, when wearing wet. Protective clothing must always be worn.
4. Avoid being in contact with the welded item.
5. Do not make any spot welding operations in very wet areas or on a wet floor.
6. Do not weld with damaged cables, always ensure that cables are in good condition. And the connections are good.
7. Before performing any maintenance operation, switch off and unplug the unit from the mains.

EYE AND BODY PROTECTION

1. During the welding process, the operator must protect himself from sparks with appropriate clothes: leather gloves, welding aprons, safety shoes, welding helmets or glasses for filtering radiations and projections. Similarly, during grinding or hammering operations, the operator must wear eye protection.
 2. The clamping force can reach 550 daN. Keep body away from the mobile elements of the clamp to avoid any risk of squeezing, of fingers in particular.
 3. Do not wear rings, watches, or jewellery, which are current conductors and can cause serious burns.
 4. All the protection boards must be in good condition and remain in place.
- Never look at a welding arc without any eye protection. Protect the environment near the product against projections and reflections.

FIRE

1. Make sure that the sparks will not cause fire, especially near flammable material.
2. Check that fire extinguishers are near the operator.
3. Use the product in a room with extractor fans
4. Do not weld on combustible or flammable material or lubricant containers (even empty)
5. Do not weld in an atmosphere containing flammable gas or fuel fumes.

ELECTRO-MAGNETIC COMPATIBILITY

Near the spot-welding machine, check whether:

- there are no other power supply cable, no control lines, no telephone cables, no radio or TV reception appliances, no watches, no mobile phones, no magnetic cards, no computers nor any other electronic appliance.
- there are, in the surroundings, no persons using active medical appliances (pacemakers, acoustic prosthetics).

Provide extra protection if products are to be used in the vicinity of the machine.

In order to protect the electronic control units on the vehicles, it is recommended to:

- disconnect the battery of the vehicle.
- disconnect the airbag control unit.
- disconnect, and even remove, the electronic control units if they are in the immediate vicinity of the welding area.

This product is designed to be used in an industrial or professional environment, as defined in the CISPR11 publication. In a different environment, it might be difficult to ensure electromagnetic compatibility.

CE MARKING

GYS testifies that this product has been designed and manufactured in conformity with the following European standards:

- Low Voltage Directive 2006/95/EC in application of the norm EN 62135-1
- Electromagnetic Compatibility Directive EMC 2004/108/EC in application of the norm EN 62135-2
- Machines directive 2006/95/EC in application of the norm EN 60204-1

2 – DESCRIPTION OF THE MACHINE

Front panel

SD card reader

Display board for user control



Rear panel



32 A D-curve circuit breaker



Pneumatic filter, connection to the pneumatic network system

X Clamp

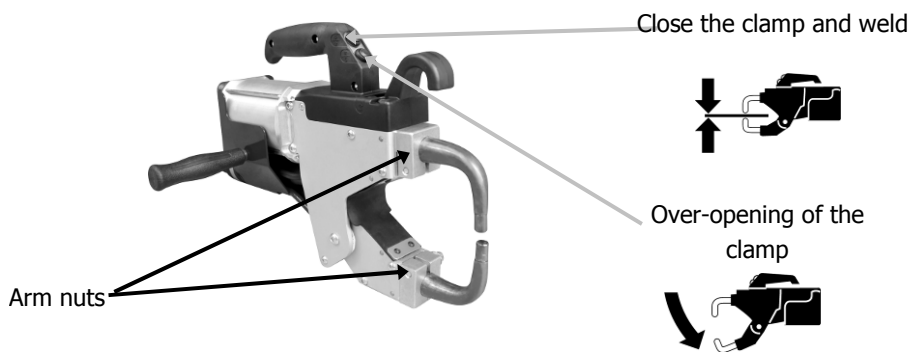

C clamp

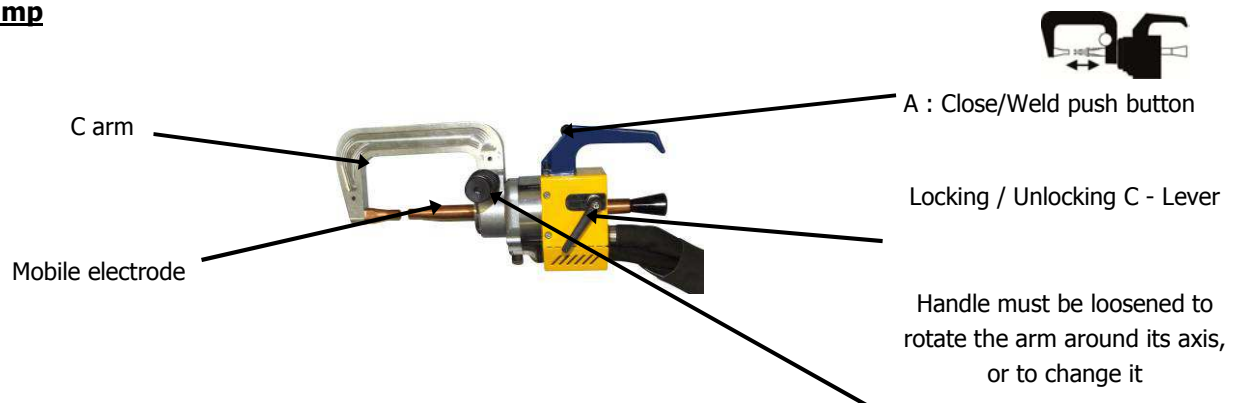

3- INSTALLATION

Before use

Several verifications are necessary before using the unit to ensure optimal machine performance.

Here are the verifications to perform:

- Check the electrical line it should be **400V**, 3 phases, with a **32 A delayed circuit breaker, curve D (or fuse of aM type)**.
- Check the cross section of the cable going from the main electrical board to the socket where the machine will be it should be **4x6 mm²**. If this cable is longer than 10m, use a conductor size of 10mm². If you use an electrical extension cord, use a 6mm² conductor size (10mm² if electrical line + extension cord total length is superior to 10m).
- Connect a **3 phase +** (minimum 32A) on the supply cable.

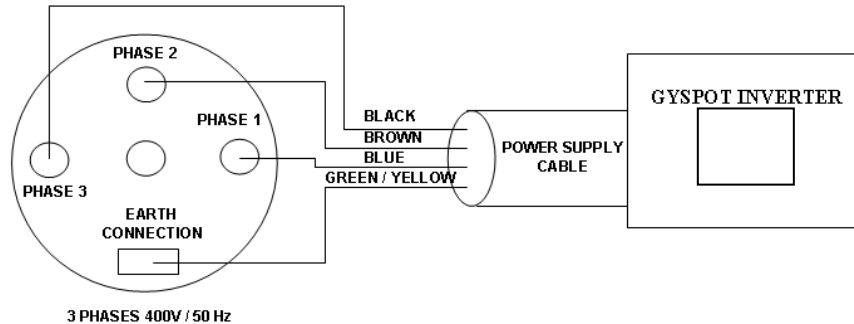

- Be careful: in order to avoid voltage drops which can generate bad welding spots, you must never have overloaded electrical lines, nor supply cable diameters which cross section that are not large enough. Also, the mains plugs must not be too far from the circuit breaker.
- If the machine is not sufficiently supplied, it is not possible to ensure a good welding quality.
- Check that the **air compressed** network can deliver a **minimum of 7 bar** (dry air), then connect the compressed air network to the back of the machine. The machine must not be used on an air compressed network with a pressure inferior to 3 bar.

Assembling earth cable

Earth cable

Assemble the copper plate on the extremity of the earth cable

This earth cable is to be used only with the single sided gun



Air connector

Assemble the air connector on the air filter.



Starting the machine

Switch the circuit breaker ON. The electronic card starts a test and and initialises the welding parameters after a period of about 10 seconds, after which the machine is ready to be used.

Cooling of the welding cables

The clamp and single sided gun cables are air cooled.

- Cooling of the clamp cable:

The air is blown into the clamp cable when the user presses the trigger.

The air continues to be blown into the cable three minutes after the last welding spot.

- Cooling of the gun cable:

The air is blown into the gun cable when the user presses the trigger.

The air continues to be blown into the cable three minutes after making the last spot with the gun.

4- EQUIPMENT OPERATION

Key definitions

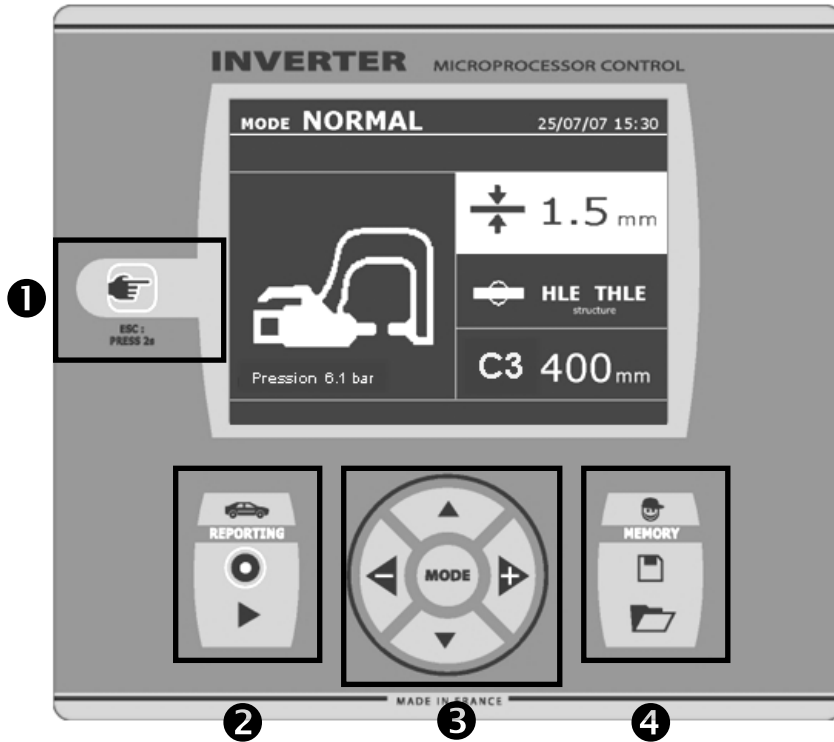

① key

- Pressing this key allows selection of the tool that will be used: clamp or single sided gun. For the BP.LCX machine, pressing this key changes the mode from C clamp to C clamp adjustment, X clamp, X clamp adjustment, and finally single sided gun. The clamp adjustment mode allows the user to close the clamp and apply the programmed force on the electrodes with any current flowing. This mode is used to adjust the arms.
- Pressing this key for 2 seconds allows user to come back to normal mode from the other modes.
- Pressing this key for 2 seconds brings the spot counter to zero, when it is displayed.
- Pressing this key briefly twice erases the report that is displayed on the screen, when in visualisation mode.
- Pressing this key when in program saving mode erases the selected program.

② Save a report

More details can be found on this function in the corresponding chapter.

The « record » key  enables or disables the report saving function.

The « visualise » key  allows user to read the sequence of spots performed.

③ Use of the advanced modes

The MODE key allows user to navigate through 4 different modes: STANDARD MODE, MULTISHEET MODE, and MANUAL MODE. A long press on the MODE key allows user to enter the configuration mode, where the language and date can be edited and the sound alarm activated for “current too low” or “low pressure” messages. The up and down keys (in the circle) allow to select the parameter to modify (sheet thickness, type of steel, arm used). The + and – keys allow to modify the parameter.

④ Saving parameters

The « save » key  allows user to save a specific user’s welding parameters (mode, sheet thickness, welding current, welding time or electrode force).

The « open » key  allows user to revert to previously saved welding settings. The machine automatically goes to manual mode, recalling the saved parameters (current, welding time, force) and the tool used (clamp or gun).

Use of the pneumatic clamps

When using a pneumatic clamp, always disconnect the earth cable used in single sided gun mode from the vehicle.

C clamp

Clamp adjustment

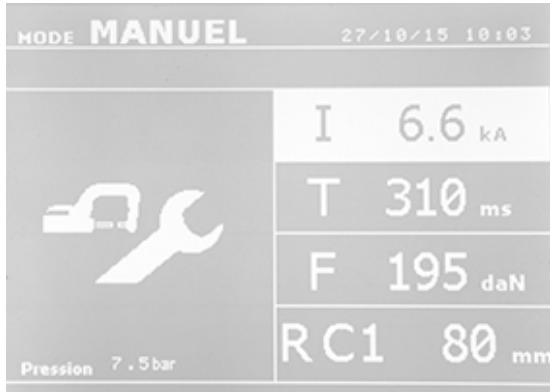

The key  allows user to switch from one tool to the next, and also allows user to enter the clamp adjustment mode. The clamp adjustment mode allows user to close the clamp and apply the selected electrode force, without delivering any current. The clamp remains closed as long as the button on the clamp is pressed. This mode allows user to check the alignment of the electrodes and the good positioning of the caps.

Standard mode

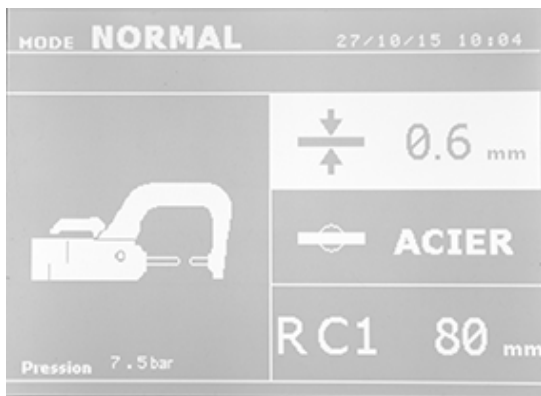

Normal mode is optional, it can be configured in the setup menu that is activated by pressing for 2 seconds.

This mode is the default mode when the machine starts. It allows the user to easily perform a welding spot by selecting:

- The tool to be used
- The thickness of the sheets to be welded, to choose from 0.6, 0.8, 1.0, 1.2, 1.5, 1.8, 2.0, 2.5, 3.0.
- The type of steel to be welded (Coated steel, HTS steel, UHTS steel, BORON steel) and the arm used.

Pressing the up and down key (in the circle) allows user to navigate from one parameter to the next (thickness, type of steel, arm used). Each parameter can be adjusted by pressing the + and - keys (in the circle).

Pressing the close / weld button allows you to perform a welding spot, using the selected parameters.

Multisheet mode

The Multisheet mode is optional, it can be configured in the setup menu which is activated by pressing the "mode" button for 2 seconds. This mode allows to precisely specify the thickness and type of each sheet, for an assembly of 2 or 3 sheets.



Using the up and down keys (in the circle) allows user to select the parameters for each sheet. When the parameters for each sheet are highlighted, the sheet thickness and type of steel parameters can be adjusted using the + and - keys (in the circle). The parameters to be adjusted in this mode are:

- The thickness of each sheet to be welded: to choose between the values 0.6, 0.8, 1.0, 1.2, 1.5, 1.8, 2.0, 2.5, 3.0 mm.
- The type of steel for each sheet: coated steel, HTS steel, UHTS steel, BORON steel.
- In order to activate sheet 3, press the up and down keys (in the circle) to highlight sheet 3; then use the + and - keys (in the circle) to select the sheet thickness and type of steel.

Pressing the close / weld button allows you to perform a welding

spot, using the selected parameters. Pressing during 2 seconds the  key takes back to the « standard » mode.

Gysteel mode

The Gysteel mode is optional, it can be configured in the setup menu which is activated by pressing the "mode" button for 2 seconds (mode Gysteel on/off).



This mode is identical to the standard mode, except that the user can define the elasticity limit of the sheet. This limit (Re) can be identified using a metal tester like Gysteel Vision.

- Re : 1-10 refers to mild steels.
- Re : 11-18 refers to HSS/THSS.
- Re : 19-35 refers to UHSS.
- Re : 36-99 refers to boron steel.

- ◆ Thickness of metal sheets: 0.6, 0.8, 1.0, 1.2, 1.5, 1.8, 2.0, 2.5, 3.0.
- ◆ The arm type which is used.

The parameters of thickness, elasticity, type of arm can be highlighted using the ▲ or ▼ keys, And adjusted using + and – keys.

Pressing the close/welding button allows to perform a welding spot, using the parameters displayed.

Pressing during 2 seconds the  key takes back to the « standard » mode.

Manual mode

This mode is displayed by default when starting the machine if the normal mode is disabled in the settings menu.

This mode allows the user to manually select the welding parameters, following instructions from a manufacturer for example.

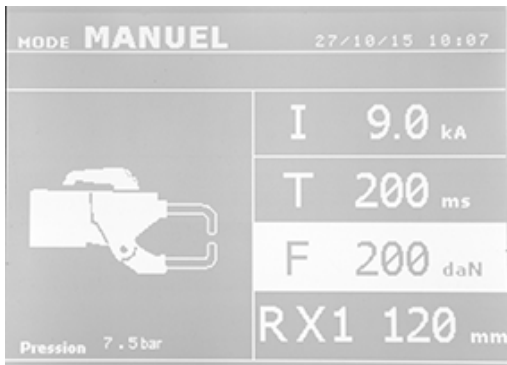

The settings proposed by default in the manual mode correspond to the settings automatically selected by the standard mode (thickness and type of sheet, electrode force, arm).

The parameters can be adjusted using the + and – keys (in the circle). The up and down keys allow user to navigate from one parameter to the next:

- Welding current (1000 to 10000 A, by steps of 100 A). Display is in kA (thousand amps).
- Welding time (from 100 to 850 ms, by steps of 10ms). Display in milliseconds.
- Electrode force (from 100 to 500 daN, by steps of 5 daN). Display in decaNewtons.

- Arm used on the clamp (arm number and length)

Pressing the close / weld button allows you to perform a welding spot, using the selected parameters.

Pressing the  key for 2 seconds takes user back to the « standard » mode.

X Clamp

Clamp adjustment

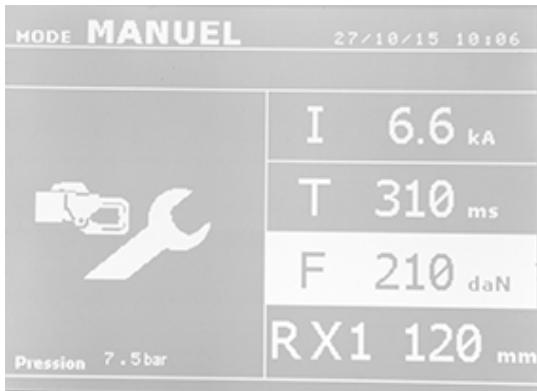

The key  allows user to switch from one tool to the next, and also allows user to enter the clamp adjustment mode. The clamp adjustment mode allows user to close the clamp and apply the selected electrode force, without delivery of any current. The clamp remains closed as long as the button on the clamp is pressed. This mode allows user to check the alignment of the electrodes and the good positioning of the caps.

Standard mode

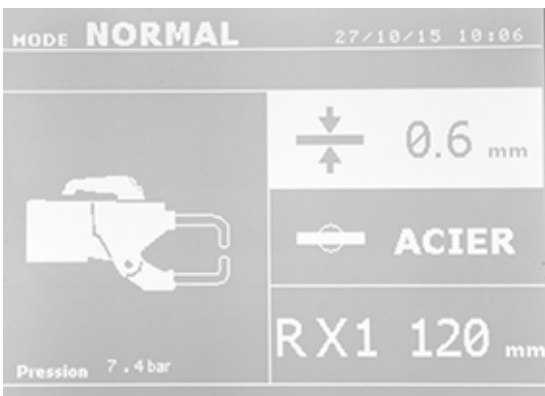

Normal mode is optional, it is configurable in the setup menu that is activated by pressing for 2 seconds. This mode is the default when the machine starts. It allows user to easily perform a welding spot by selecting:

- The tool to be used
- The thickness of the sheets to be welded, to choose from 0.6, 0.8, 1.0, 1.2, 1.5, 1.8, 2.0, 2.5, 3.0.
- The type of steel to be welded (Coated steel, HTS steel, UHTS steel, BORON steel) and the arm used.

Pressing the up and down key (in the circle) allows user to navigate from one parameter to the next (thickness, type of steel, arm used). Each parameter can be adjusted by pressing the + and – keys (in the circle).

Pressing the close / weld button allows to perform a welding spot, using the selected parameters.

Multisheet mode

The Multisheet mode is optional, it can be configured in the setup menu which is activated by pressing the “mode” button for 2 seconds.

This mode allows user to precisely specify the thickness and type of each sheet of an assembly of 2 or 3 sheets.



Using the up and down keys (in the circle) allows user to select the parameters for each sheet. When the parameters for each sheet are highlighted, the sheet thickness and type of steel parameters can be adjusted using the + and – keys (in the circle).

The parameters to be adjusted in this mode are:

- The thickness of each sheet to be welded: to choose between the values 0.6, 0.8, 1.0, 1.2, 1.5, 1.8, 2.0, 2.5, 3.0 mm.

The type of steel for each sheet: coated steel, HTS steel, UHTS steel, BORON steel. In order to activate sheet 3, press the up and down keys (in the circle) to highlight sheet 3; then use the + and – keys (in the circle) to select the sheet thickness and type of steel.

Pressing the close/welding button allows to perform a welding spot, using the parameters displayed.

Pressing the  key for 2 seconds takes user back to the « standard » mode.

Gysteel mode

The Gysteel mode is optional, it can be configured in the setup menu which is activated by pressing the "mode" button for 2 seconds (mode Gysteel on/off).



This mode is identical to the standard mode, except that the user can define the elasticity limit of the sheet. This limit (Re) can be identified using a metal tester like Gysteel Vision.

- Re : 1-10 refers to mild steels.
- Re : 11-18 refers to HSS/THSS.
- Re : 19-35 refers to UHSS.
- Re : 36-99 refers to boron steel.

- ◆ Thickness of metal sheets: 0.6, 0.8, 1.0, 1.2, 1.5, 1.8, 2.0, 2.5, 3.0.
- ◆ The arm type which is used.

The parameters of thickness, elasticity, type of arm can be highlighted using the ▲ or ▼ keys, And adjusted using + and – keys.

Pressing the close/welding button allows to perform a welding spot, using the parameters displayed.

Pressing the  key for 2 seconds takes user back to the « standard » mode.

Manual mode

This mode is displayed by default when starting the machine if the normal mode is disabled in the settings menu.

This mode allows the user to manually select the welding parameters, following instructions from a manufacturer for example.

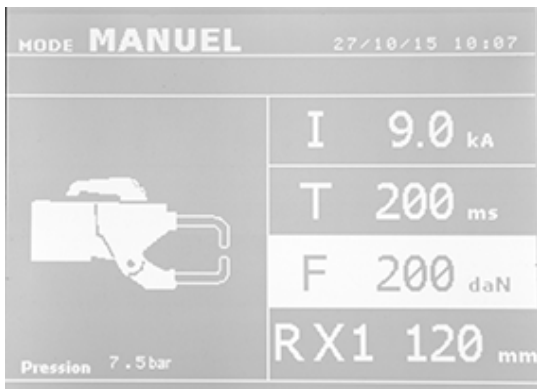

The settings proposed by default in the manual mode correspond to the settings automatically selected by the standard mode (thickness and type of sheet, electrode force, arm).

The parameters can be adjusted using the + and – keys (in the circle). The up and down keys allow to navigate from one parameter to the next :

- Welding current (1000 to 10000 A, by steps of 100 A). Display is in kA (thousand amps).
- Welding time (from 100 to 850 ms, by steps of 10ms). Display in milliseconds.
- Electrode force (from 100 to 500 daN, by steps of 5 daN). Display in decaNewtons.
- arm used on the clamp (arm number and length)

Pressing the  key for 2 seconds takes user back to the « standard » mode.

Use of the single sided gun

- ◆ Connect the copper plate to the generator's earth cable.
- ◆ Firmly fix the earth plate as near as possible to the welding area.

In case of single sided welding with the single sided gun, always fix the earth plate on the sheet that is not in contact with the welding electrode (such that the welding current will flow the 2 sheets to be welded).

- ◆ Select the GUN tool using  key, or pulling the gun's trigger.
- ◆ The default parameter is star welding in standard mode.

! Never let the inertia hammer at the end of the gun if this one is hung to the balancer.

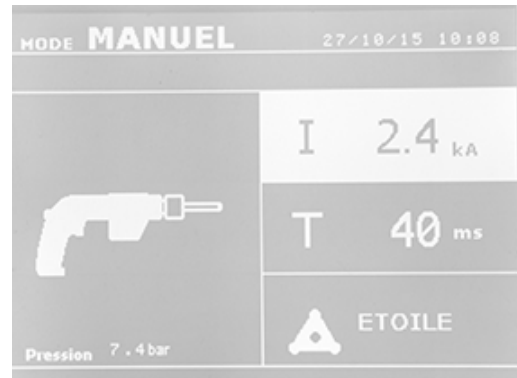
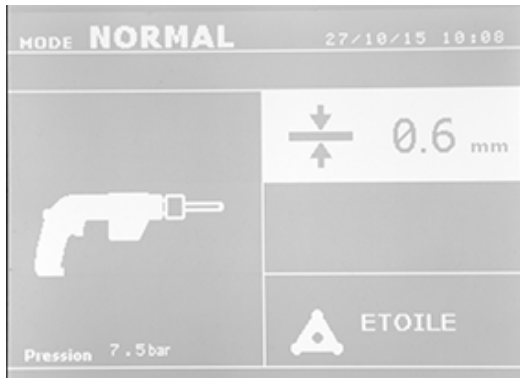

The single sided gun can be used in standard or manual mode.

- ◆ In normal mode, the single sided gun will be limited to steel sheets of thickness 1.5mm maximum.

With the single sided gun, the operator can choose between a variety of tools (single point welding, star welding, stud welding, rivet welding, washer welding, carbon shrinking, stitch welding) The selection of the tool is performed using the + and - keys.

In manual mode, the maximum welding current is 9 kA during a period that will not exceed 500 ms. This is why it is not possible to select higher values for these parameters.

Select the thickness of the sheets to be welded on the machine, using the + and - keys. It is possible to modify the parameters for current and time in manual mode

Pressing the  key for 2 seconds takes user back to the « standard » mode.

The highlighting allows user to select the parameter to adjust. Each parameter can be adjusted using the + and - keys. The up and down keys allow to move from one parameter to the next.

WARNING:

The clamp and the gun of the unit are connected to the same current source. This means that when you use one of these 2 tools, there is also power on the second tool. The tool which is not used must therefore be placed on its stand on the trolley (clamps stand located on the side of the trolley and gun stand located on the T-Shape balancer).

If instructions are not followed, severe damage can occur to the generator tools. Sparks and metal projections can occur.

Error management

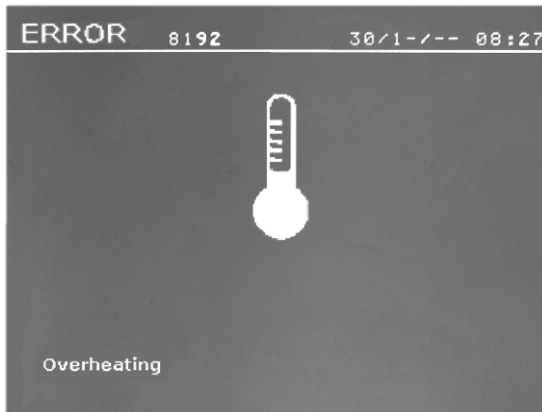

Different events might cause the appearance of error messages. They can be classified in three categories:

- The messages that warn the user, of overheating, or a lack of electrode force or welding current, etc... These messages appear on the screen, and remain until a key is pressed.
- the defects that correspond to a bad installation (air pressure, electrical power supply)
- The messages that inform of major failures, such as material failure. These defects cause the display of an error message that blocks the machine.
- The thermal protection makes use of a thermistor on the diode bridge, which block the use of the machine, and displays the message "overheating".

Current too low



If the welding current obtained during the welding spot is 6% less than the current setting, the machine displays, once the welding spot is performed, an error message "Current too low", warning that the welding spot should be checked.

A message is displayed at the end of the welding spot showing the actual measured welding current. This message is displayed on the screen until a key is pressed on the control panel, or until a new welding spot is performed, by pressing the button on the clamp.

If the machine cannot deliver the requested current, then the following message appears. The welding spot is not performed, and the message must be acknowledged to perform a welding spot.

Insufficient air pressure

If the input air pressure is too low to reach the requested electrode force, the machine will beep and display, before the welding spot, the following error message "Insufficient Pressure".

Pressing on the button allows user to force the execution of the welding spot, which will be performed with the air pressure available. If the actual measured clamping force is too low, then the machine will display the following message "Low Pressure".



Welding spot counter

A welding spot counter allows user to count the number of spots performed with the same caps. If the welding spot is performed without any problem, the following message appears.

The counter is displayed on the top left corner of the screen. Pressing the key  for two seconds resets this counter to zero, after the caps have been replaced.

If more than 200 welding spots are done with the same caps, then the machine will display a warning message. In this case, the warning message "Do control caps" is also recorded in the traceability report. You can define the threshold number of spots, 200 by default.

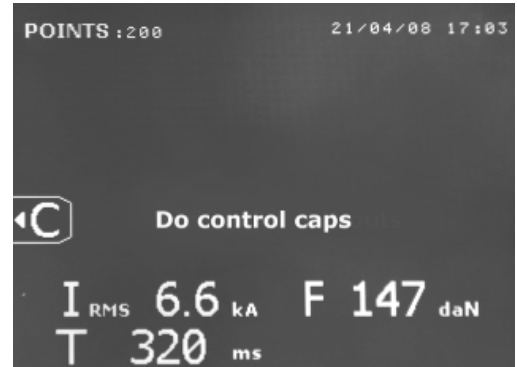

Recording features

The log report allows user to save the characteristics of the welding spots performed with the clamp. It is available from all modes, by simply pressing the keys located below the icon "REPORTING".

The user welding parameters mode is also available from all modes, by pressing the keys below the icon "MEMORY".

LOG report

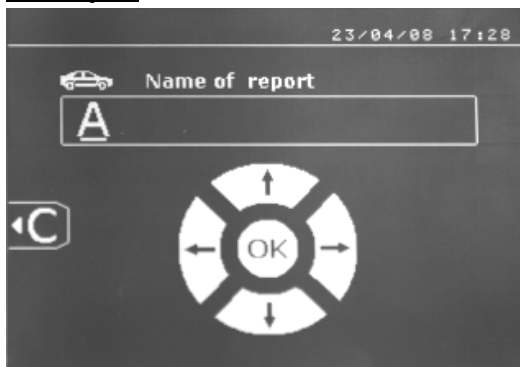

Recording a report allows user to save the characteristics of a series of welding spots, and save them on the SD memory card, so that they can be transferred to any standard PC. GYS provides a software to read the SD card, and edit reports. This GYS POT software is stored in the SD card, together with a copy of the user manual.

By default, this function is disabled at the start of the machine.

Pressing the key  and the "mode" key allows user to start recording in the selected log file. Pressing the record key again will stop the record.

The log file thus created contains: an identifier entered by the user, as well as, for each welding spot performed, the tool used, the arms used, and the settings of the machine (welding current and electrode force). It also contains the possible error messages that have been displayed during the record: I low, P low. Use the + and - keys, as well as the up and down keys to enter the identifier. If a previously existing identifier is entered, the machine will save the new welding spot characteristics at the end of the file, without erasing any information from the file.

The key  allows to recover a report previously saved and to read it on the screen.

Before visualizing a report, the record must be stopped by pressing the  key.

The "mode" key allows to exit the report visualisation mode.

To erase the content of a report, display it on the screen using the « visualize »  key.



Then, press the key .

The following message appears on the screen:



When the triangle sign is displayed, pressing key  a second time erases the contents of the report displayed on the screen. The triangle sign disappears from the screen after 3 seconds

Identification mode :

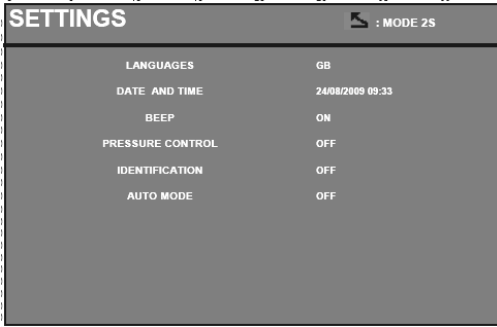

If the identification mode is set to "ON", then you should enter the data for all required fields otherwise the machine will show the "defect identification" error message.

To enable and disable the identification mode, insert an identification SD card instead of the SD card that contains the programmes.

The screen below setup is activated by pressing on the mode button for 2 seconds.

When the SD card "identification" is inserted and you select "identify ON" THEN the following SUPERVISION screen appears.

This screen allows you to enter data in the fields "Registration, vehicle make, vehicle model, vehicle identification number" which are required when entering the repair order.

To exit the screen, you must press the mode key for 2 seconds. Then you must put the SD card that contains the program into your BP card reader.

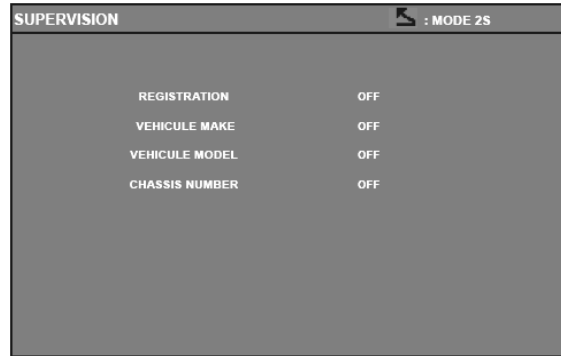

List of screens that allow you to enter a repair order:

When a job number has already been created, it can not be changed or deleted on the BP. To remove it you must use the software GYSPOT PC. You can create up to 100 job numbers.

Display: 'Job number'

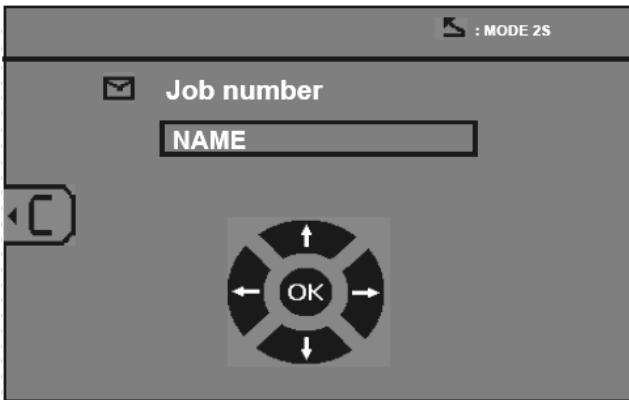

Display: 'User ID'

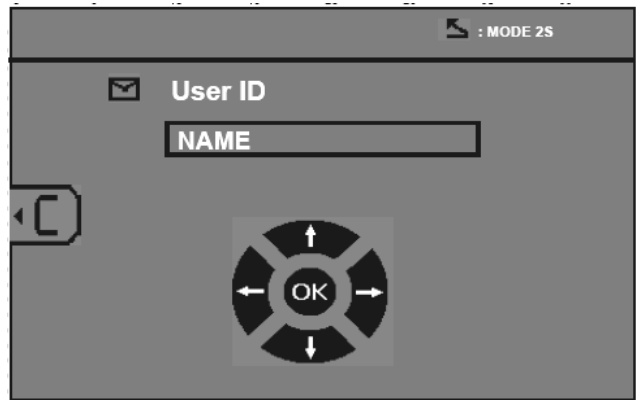

'left' and 'right' keys moves the cursor in the field.
 The up and down buttons allow you to change the letters or numbers
 The Esc key clears the field.
 The mode button allows scrolling between various fields for modification or checking.

Display: 'Registration' (optional)

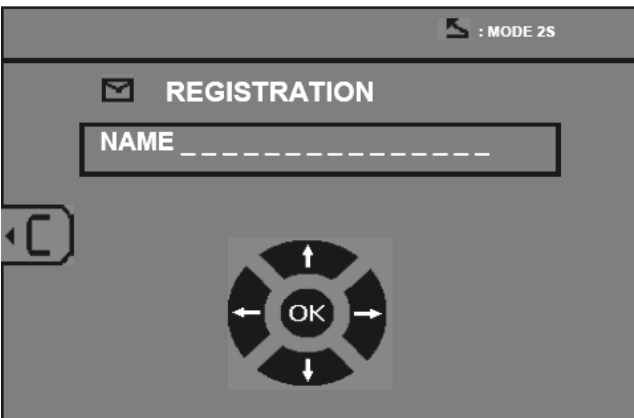

Display: 'Vehicle make' (optional)



Display: 'Vehicle model' (optional)

Display: 'Chassis number' (optional)

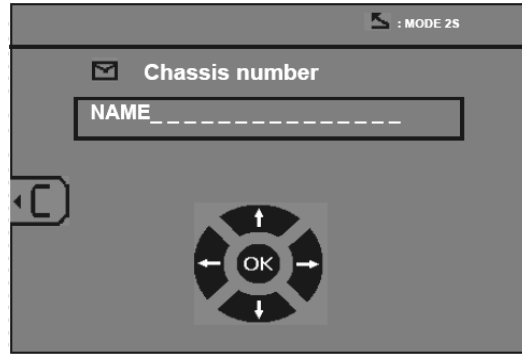
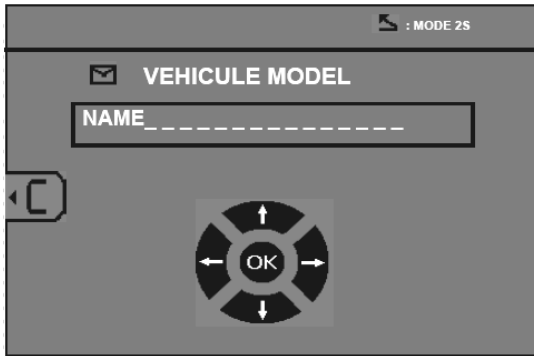

Catalogue

When consulting jobs with the View key , the CATALOG screen appears :
 The page number is displayed (13 maxi)
 Keys 'left' and 'right' are used to switch pages. The up and down keys are used to select the next or previous Job number.
 The "mode" key enables the display of the selected repair order.

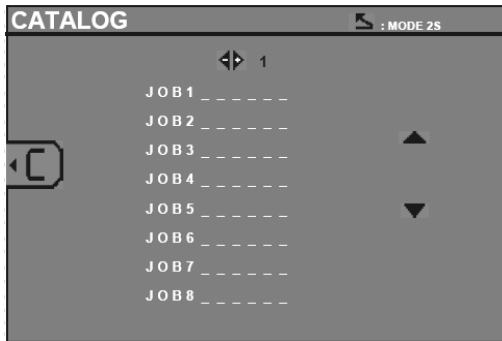

N°	X/C	I(kA)	F(daN)	Observation
1	X1	8.1	200	
2	X1	8.0	200	
3	X1	8.0	515	P FAIBLE
4	X1	8.1	515	P FAIBLE
5	X1	8.0	110	

The "mode" key is used to exit the report screen.

- ◆ The library management can handle SD cards > 2 GB.
- ◆ Each job has an associated log file xxx.dat. (xxx = id from 001 to 100). In every report, the maximum recorded spot welds is 500. The job number and the user id are displayed.
- ◆ No. The page is shown in the top left.
- ◆ All jobs are stored in the file catalog.GYS.
- ◆ It contains the total number of jobs, the name of each job and user id (max 100 jobs).

User welding parameter record

The saving of user welding parameters allows user to save the preferred welding parameters for different users of the machine. 20 user profiles can be saved. Each of them contains the following settings: tool, arm, welding current, welding time, electrode force).

A user can save his preferred parameters for the clamp or single sided gun.

The save key  allows to record the settings currently used in manual mode (welding current, welding time, electrode force). The 20 user profiles are then displayed with either an identifier, for those that are already used, or « --- » for those that are still available.

Use the + and - keys, as well as the up and down keys, are used to enter the identifier. When entering a previously used identifier, the machine will erase the previously saved settings.

The « Open » key  allows to access the user profiles previously saved. Selecting an empty user profile has no effect.

Pressing briefly the key  erases the selected program in the list of saved programs.

The "mode" key allows to exit the program selection mode, and makes the machine enter the manual mode where the parameters and the tool saved in the program are recalled.

To disable a program, simply change the value of a parameter in manual mode, standard mode or mutisheet mode, or simply change tool by pressing the key .

SD memory card

SD card reference: 050914

This card allows the user to transfer files from the machine to a PC to:

- Collect log reports in order to keep a work trace, and possibly show it to an insurance company.
- Update welding parameters, add new menu languages.
- A copy of the GYSPOT software to collect and edit the traceability reports is stored on the SD card.
- A copy of the user manual is also stored on the SD card.



The memory space will save the characteristics of more than a 1 000 welding spots.

The machine can operate without any SD card only in manual mode.

If the memory card is not inserted in the card reader, then the following message is displayed.

Important: Switch off the machine, insert the SD card, and switch the machine ON again. The machine shall be switched off before removing the SD card from the reader otherwise the data on the SD card may be corrupted.

GYSPOT SOFTWARE FOR PC

The purpose of this software is to allow the user to edit or save reports of the welding spots performed during a car body repair with a GYSPOT machine. In order to use this software, the PC (Personal Computer) must be equipped with an SD memory card reader.

Language selection

The software is available in several languages. By default, the following languages are available: French, English, German, Spanish, Dutch, Danish, Finnish, Italian, Russian, Swedish, Turkish.

To select a language, click on **Options**, and then on **Languages** in the menus.

Beware, once the language is selected, the user should exit and start the GYSPOT software again to select a new language

User identity

In order to customise the information that appears on the reports, the user should fill some data in the software. To enter this data, click in the menus on **Options**, and then on **Identity**. A new window appears with the following information:

Company name

Address/ Postal code/ Town

Telephone/ Fax

Email/ Website/ Logo

This information will automatically be displayed on the reports.

Import log reports saved on the SD card

In order to import reports of welding spots performed with the GYSPOT machine on a PC, insert the SD memory card in the card reader of your PC, and then start the GYSPOT software.

Then, select the location where your memory card is inserted, and click on the import icon .

Once the data import is completed, the welding spots performed are sorted by an identifier of the repair order. This identifier corresponds to the name of the report in the spot welding machine. This identifier is displayed in the **Active** tab.

When all the reports have been imported, it is possible to perform a search, edit or archive each report. To visualise the characteristics of welding spots in a report, select the report; the characteristics of each spot appear in a table.

To perform a search, fill the search field, and click on icon .

To edit a report, select the report, and click on icon .

To archive a report, select the report and click on icon .

Beware, the imported reports cannot be deleted if they have not been previously archived.

Visualise log reports of welding spots

To visualise log reports, click on the **Archive** tab. The reports are sorted by year and month. To visualise the characteristics of the welding spot performed, select a report: the data corresponding to each welding spot appears in a table.

For the archived reports, it is possible to perform a search, edit or delete a report.

Beware, a report which is archived, and then deleted, will be imported again in the next import operation unless the SD card has been formatted.

To perform a search, fill the search field, and click on icon .

To edit a report, select the report, and click on icon .

To delete a report, select the report, and click on icon .

Format of the SD card

A format operation on the SD card will erase all the reports previously saved on the SD card.

To format the SD card, insert the SD card in the reader of your PC and, in the menus, click on **Options** and **Purge/format SD Card**.

Beware, during a purge operation, the reports that have not yet been imported in the software will be automatically imported.

Filling the information of a report

The following information can be automatically added to each report:

- Operator, Brand, Vehicle model
- Registration, First registration,
- Chassis number, Operation, Remarks.

To fill this data, select a report and enter this information in the header of the report.

Print a report

To print a report, select the report and click on icon . A print preview appears. Click on icon .

Export in PDF format

To export a report in PDF format, select a report, and click on icon .

A print preview appears. Click on icon .

Example of report :

	Company name : S.A.S. GYS	Phone number : 0243012360
	Address : 134 BOULEVARD DES LOGES	Fax number : 0243012360
	...	Email : contact@gys.fr
	Zip code : 53941	Website : www.gys-soudure.com
	City : SAINT BERTHEVIN	

Operator : DUPOND Jean-Pierre	Vehicle : MEGANE CC 1.6L 16V
Repair order : 455B	Registration : 1600SW53
Report date : 13/05/2008	First Registration : 21/01/2005
Remarks : RAS	Operation : REDRESSAGE AILE ARRIERE GAUCHE

GYSPOT INVERTER BP. LC (0000001000)

Point n°	Date / Hour	Mode	Tool	Settings			Measurements		State
				Time (ms)	Intensity (kA)	Force (dall)	Intensity (kA)	Force (dall)	
1	05/05/2008 11:11:21	Normal	X clamp n°1	310	6,6	195	6,5	195	Point OK
2	05/05/2008 11:11:25	Normal	X clamp n°1	310	6,6	195	6,5	195	Point OK
3	05/05/2008 11:11:29	Normal	X clamp n°1	310	6,6	195	6,5	195	Point OK
4	05/05/2008 11:11:33	Normal	X clamp n°1	310	6,6	195	6,5	195	Point OK
5	05/05/2008 11:11:48	Manual	X clamp n°1	310	6,6	550	6,5	480	LowPressure
6	05/05/2008 11:11:54	Manual	X clamp n°1	310	6,6	550	6,5	480	LowPressure

5- PRECAUTIONS AND SERVICING

User training

Operators must have an appropriate qualification for the use of the machine in order to get the best from the unit and to perform a satisfying job (e.g. : car-body repair training).

Preparation of the parts to assemble:

It is essential to grind, clean and prepare the part to be welded.

In case of a protection application, first verify that it is conductive by testing a sample.

Single sided gun welding

Before repairing a vehicle, check that the car manufacturer authorises the welding process you have chosen.

Use of the under fender arm

The maximum pressure is 200 DaN.

X clamp's nuts circular joints

Inside the 2 tightening arms nuts (see description of the clamp), there are 2 circular joints which have to be replaced in case of leaks or every 6 months. These 2 circular joints are necessary to prevent risks of cooling liquid leaks.

These joints have a diameter of $d=25$, flange=4. During replacement, it is advised to add copper grease on these joints to ease insertion of the arms (copper grease reference : ref. 050440).

Purge of the pneumatic filter

Regularly drain the dehumidifier filter placed on the rear side of the unit.

Generator maintenance

The maintenance and repair of the current generator must be done by an appointed and GYS trained technician. Any maintenance operation done by another person will void the warranty. GYS cannot be held responsible for damage or accidents subsequent to operations performed by people outside of GYS.

Cleaning or replacement of the welding tools

Any welding tool is degraded after a certain period of use. All tools must stay clean in order to achieve the best results. When using the unit in pneumatic clamp mode, check the state of the CAPS electrodes (flat, rounded or bevelled). If this is not the case, clean them with sandpaper (fine grain) or replace them (see reference on the unit).

For a use in single sided gun mode, it is necessary to check the state of the tools: stars, single point electrode, carbide electrode, and if they look in bad conditions clean or replace them.

Replacement of the caps/electrodes:

- To ensure an efficient welding spot, it is necessary to replace the caps every 200 spots, using the dedicated tool.
- Assemble the caps with copper grease (ref. 050440)
- A type caps (ref. 049987)
- F type caps (ref. 049970)
- Bevelled caps (ref. 049994)
- Several combinations are possible

Warning: The caps must be perfectly aligned. If not, check that the electrodes are in line. (cf. replacement of arms p. 18 and 19).

Replacement or adjustment of X-Clamp arms

When changing the arms, place the clamp on its stand, and proceed as follows:

- The machine must be switched off.
- Unscrew the tightening screws of the arms nuts.
- Take the other arms, put some grease all around the arm's extremity (use special "copper grease").
- Put the arms back and set on mechanical stop. Adjust them so that both electrodes face each other. Then screw both screws of the arms nuts (couple 15 Nm).

X (Ø 25mm) + Caps Ø 13mm

X1 Ref 050501 8 bar / 550 daN $l = 120$ mm

X2 Ref 050518 8 bar / 400 daN $l = 220$ mm

X5 Ref 050549 8 bar / 200 daN $l = 180$ mm

X6 Ref 050587 8 bar / 400 daN $l = 220$ mm

X4 Ref 050532 8 bar / 120 daN $l = 440$ mm

X11 Ref 051607 3 bar / 150 daN $l = 200$ mm

X4A Ref 020702 8 bar / 150 daN $l = 350$ mm

X4B Ref 020719 8 bar / 150 daN $l = 350$ mm

X4C Ref 020726 8 bar / 150 daN $l = 350$ mm

X4 (A,B & C) combinations

X4A + X4A X4A + X4C

X4B + X4B X4A + X4B

X4C + X4C X4C + X4B

X (Ø 25mm)

RX1 $l = 120$ mm
Ref 051034
8 bar / 500 daN

RX2 $l = 220$ mm
Ref 051041
8 bar / 300 daN

RX3 $l = 220$ mm
Ref 051058
8 bar / 300 daN

Panneaux de bras

X2 + X3 + X5
Ref 018785 (LIQUID)

X4A (x2) + X4B + X4C + X2
Ref 020733 (LIQUID)

X clamp overheating

Number of spots before the machine stops due to overheating

	0,6mm	0,8mm	1mm	1,2mm	1,5mm	1,8mm	2mm	2,5mm	3mm
STEEL	77	65	55	46	37	31	28	23	20
HSS	60	50	44	39	33	27	25	21	18
UHSS	45	37	33	30	25	21	19	16	14
BORON	50	44	39	35	28	24	20	17	15

The time for cooling the clamp can reach 15mn.

Number of spots between 2 stops due to overheating

	0,6mm	0,8mm	1mm	1,2mm	1,5mm	1,8mm	2mm	2,5mm	3mm
STEEL	23	20	16	15	14	13	12	10	8
HSS	18	16	14	13	12	11	10	8	7
UHSS	14	12	11	10	9	8	7	6	5
BORON	16	14	13	12	10	9	8	7	6

Replacement or adjustment of C-Clamp arms:

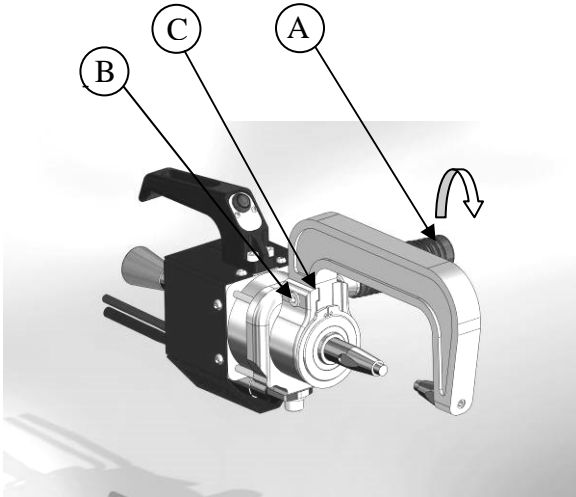

Proceed as follows :

- Unscrew the handle (A)
- Unscrew the screw maintaining the arm and the clamp (B).
- Remove the arm from the clamp (C).
- Take another arm and insert it in the clamp; put some copper grease on the extremity of the arm
- Screw to assemble arm and clamp (B)
- Screw the handle again

C clamp mobile electrode setup:

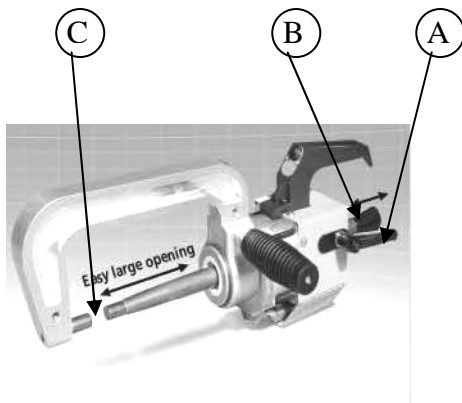

Proceed as follows:

1. The machine must be switched off.
2. Release the movable electrode from the nut by unscrewing the locking handle (A).
3. Adjust the position of the movable electrode by sliding through the sleeve (B).
4. Opening between the 2 caps (C) should be about 10 mm.
5. Set the movable electrode in the nut tightening the locking handle (A).

Types of arms for the C clamp

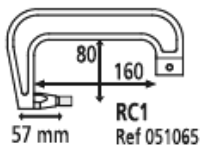

RC1
Ref 051065
8 bar / 300 daN

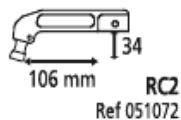

RC2
Ref 051072
8 bar / 300 daN

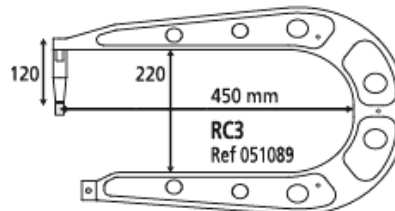

RC3
Ref 051089
8 bar / 300 daN

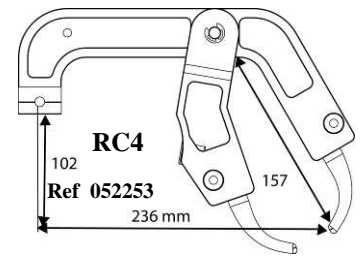

RC4
Ref 052253
8 bar / 120 daN

C clamp overheating

Nombre de points avant la première coupure thermique







	0,6mm	0,8mm	1mm	1,2mm	1,5mm	1,8mm	2mm	2,5mm	3mm
ACIER	110	90	76	61	48	39	36	22	18
HLE	90	75	62	48	38	32	26	18	15
UHLE	62	48	44	36	28	23	19	15	12
BORON	75	60	47	40	33	25	22	16	13

The time for cooling the clamp can reach 15mn.

Number of spots between 2 stops due to overheating default

	0,6mm	0,8mm	1mm	1,2mm	1,5mm	1,8mm	2mm	2,5mm	3mm
ACIER	64	56	42	32	20	16	14	10	8
HLE	54	36	32	22	16	13	12	10	8
UHLE	32	22	18	15	12	10	9	8	7
BORON	42	36	20	16	14	11	10	8	7

6 – ASSEMBLY INSTRUCTIONS

M8 x 12	M8 x 85	M8 x 100	M6 x 20	M8	Vis tôle
					
X43	X1	X1	X12	X39	X2

1

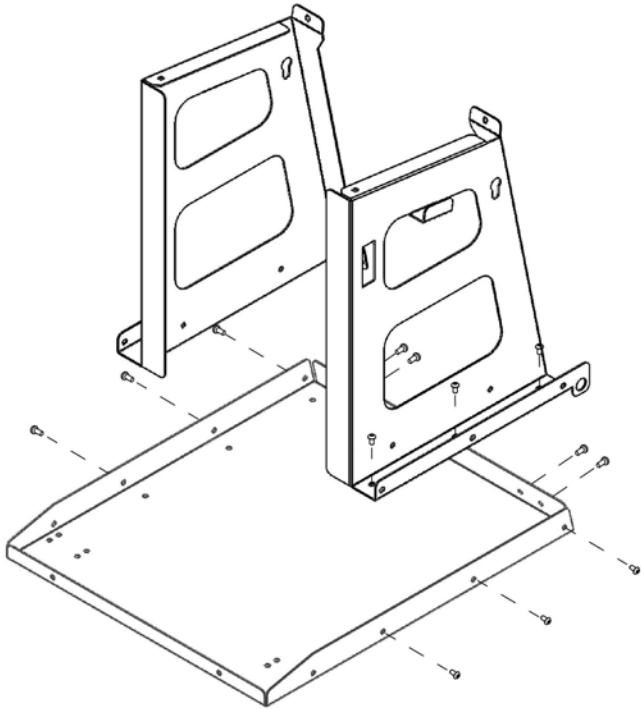

16 M8x12
16 M8

2

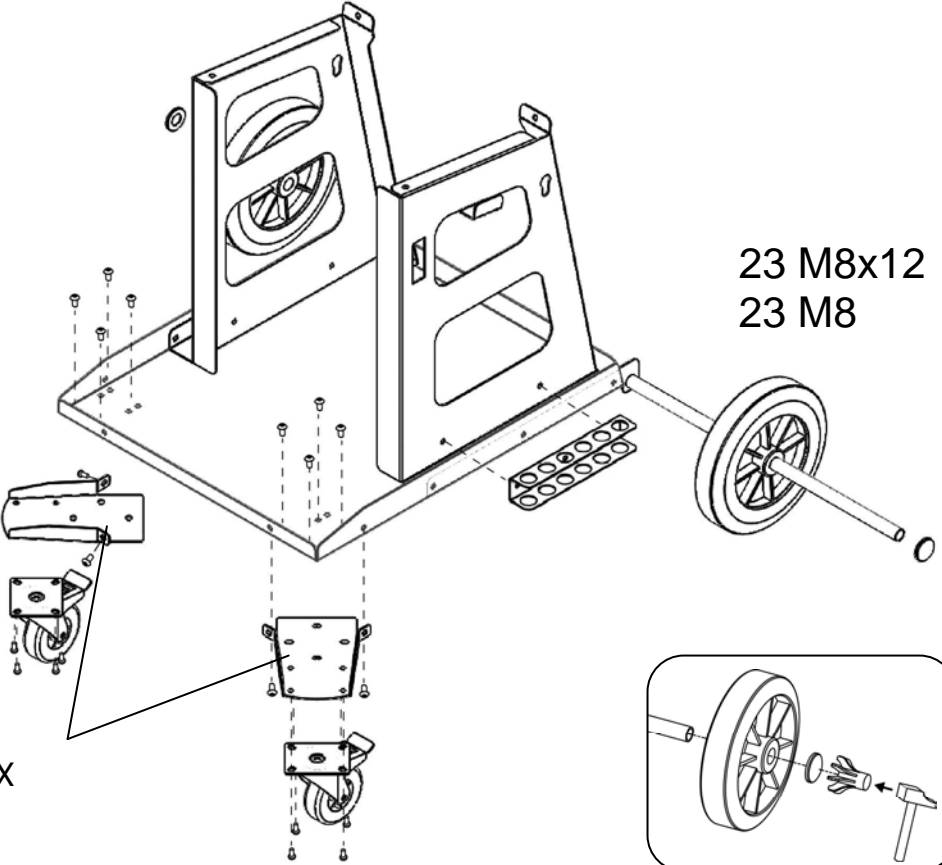

23 M8x12
23 M8

Only
100 R CX

3

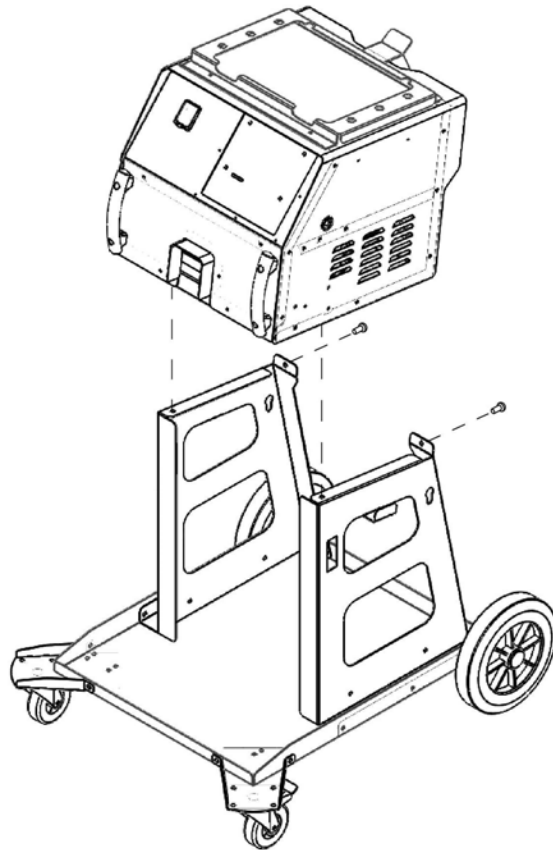

4 M8x12

4

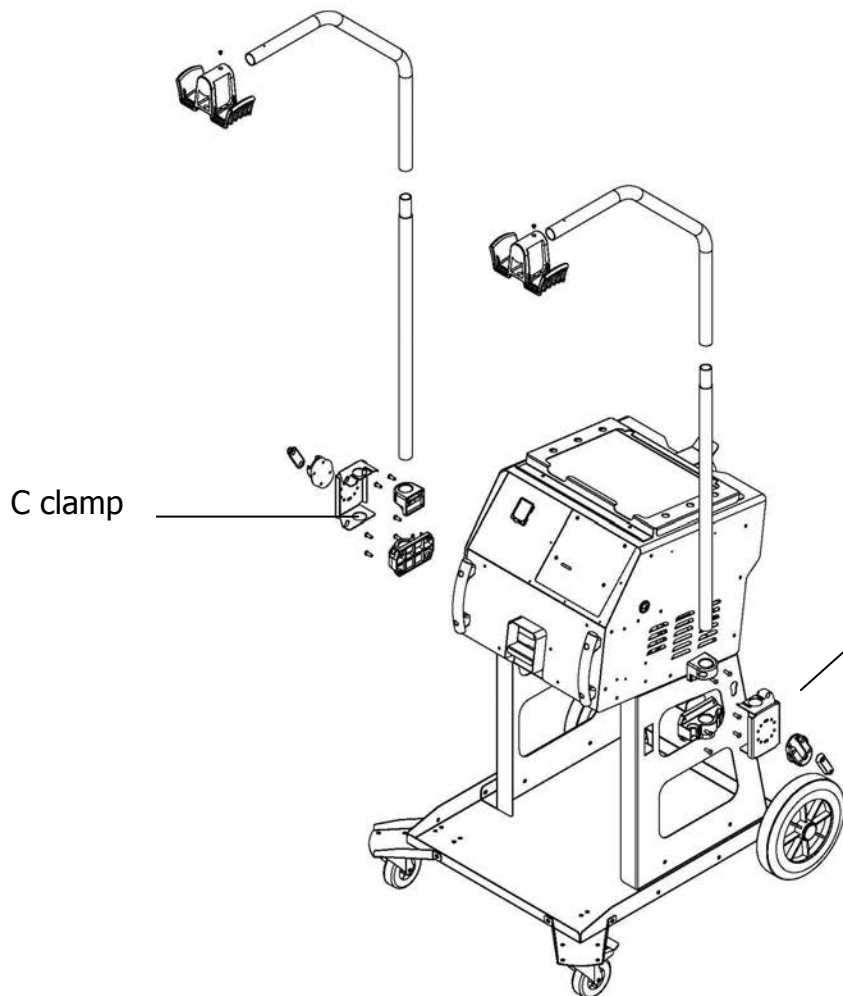

12 M6x20
2 tôles

C clamp

X clamp

5

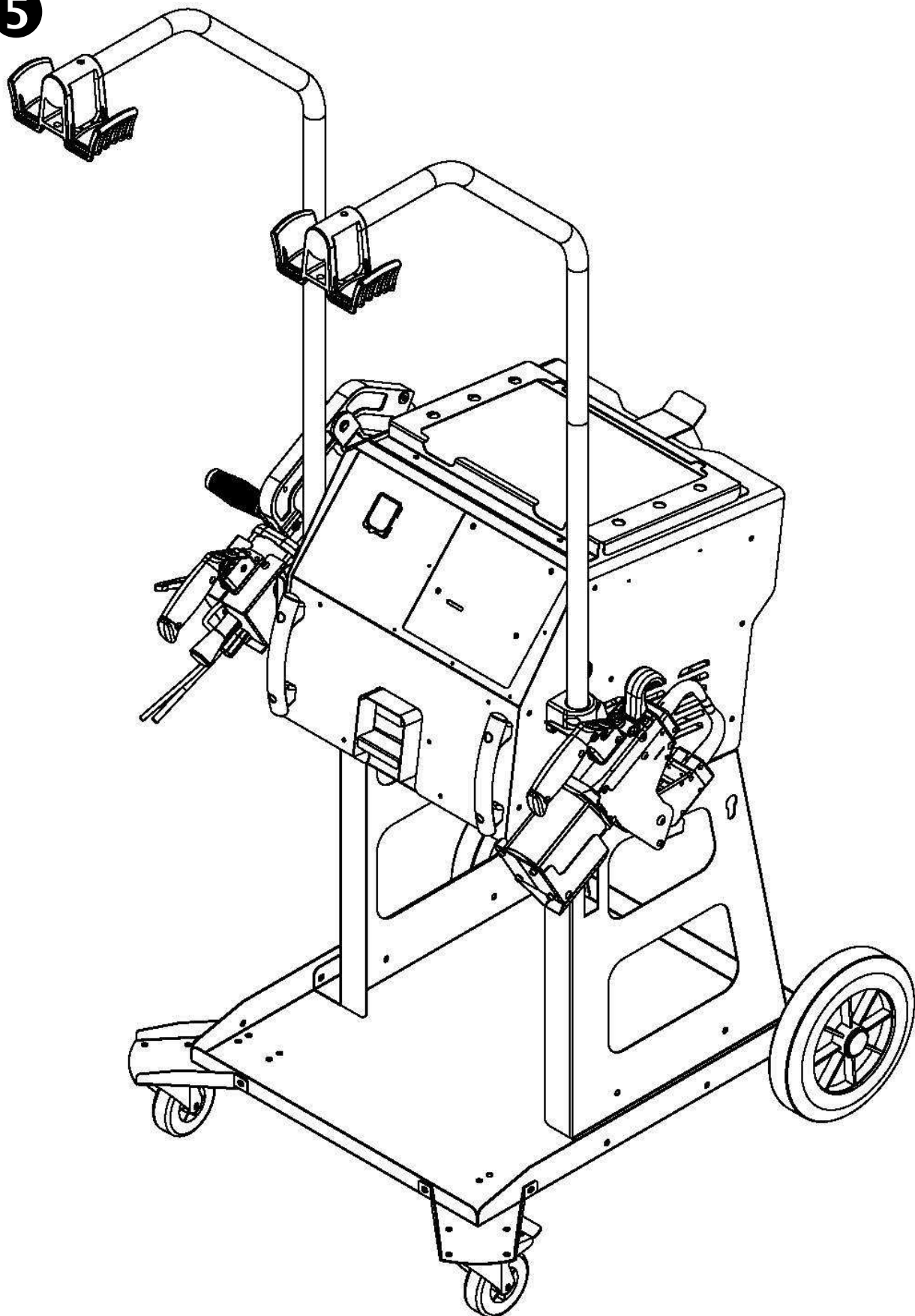







7 – TECHNICAL CHARACTERISTICS

ELECTRICAL CHARACTERISTICS	
Nominal input voltage : U1N	400V 3 phases + earth 50/60Hz
Permanent input current : I1N	32 A
Power at 50 % duty factor : S50	6,4 kVA
Permanent input power : Sp	4,5 kVA
Maximum welding input power : Smax	70 kVA
Secondary voltage : U2d	16 VDC
Maximum short-circuit output current: I2cc	10 000 A
Maximum permanent output current : I2P	560 A
Maximum regulated welding current	10 000 A
Circuit breaker	32 A courbe D
Duty cycle	0.5 %
F1-F2 : Fuse 6.3x32	T2A - 500 VAC
F3 : Fuse 6.3x32	AR1.6A - 1000 VDC
THERMAL CHARACTERISTICS	
Ambient temperature range	+5°C +45°C
Transport and storage temperature range	-20°C +70°C
Hygrometry	80 %
Altitude	2000m
Thermal protection on the rectifier	70 °C
MECHANICAL CHARACTERISTICS	
Protection degree	IP21
Width	700mm
Depth	990 mm
Height	208 mm
Weight	105 kg
PNEUMATIC CHARACTERISTICS	
Maximum air pressure P1	8 bar
Minimum regulated force : F min	100 daN
Maximum regulated force with X clamp and 120 mm arms : F max	550 daN
Maximum regulated force with X clamp and 440 mm arms : F max	130 daN
Maximum regulated force with C clamp : F max	350 daN
Maximum regulated force with C clamp and RC4 arms : F max	120 daN

8 – TROUBLESHOOTING

ANOMALIES		CAUSES	REMEDIES
Clamps	The 'spot' weld is of poor quality	The metal surface has not been prepared properly	Check the preparation of the surface
		The caps are damaged/used	Change the caps
		The fitted arm is incorrect	Check the arm that has been selected in the software
	The clamps have pierced the metal	Insufficient air-pressure	Check the system pressure (min. 7 bar)
		The caps are damaged/used	Change the caps
		The metal surface has not been prepared properly	Check the preparation of the surface
	Lack of power on clamps C or X	Electrical supply problem	Check the stability of the power supply
		The caps are dirty or damaged	Change the caps
	The generator has gone into Thermal Protection Mode	The machine has been used intensively	Refer to the Heating Tongtable (p 18 & 19)
		Insufficient cooling-Air pressure too low	Check the system pressure (min. 7 bar)
Gun	No power in the gun	Bad Earth connection	Check the Earth connection/cable
		Insufficient tightening of the chuck or accessories	Check the tightening of the chuck or accessories
		The consumables are damaged	Replace the consumables
	The gun over-heats	Insufficient tightening of the chuck or accessories	Check the tightening of the chuck, the chuck exit, and the sheath.
	The spot is poor quality	Bad Earth connection	Check the Earth connection / cable and the contact

9 - ICONS

V	Volts
A	Amps
3 ~	Three-phase power supply
U 1n	Nominal input voltage
S p	Permanent input power
S max	Maximum welding input power
U 20	Alternating current defined unload
I 2 cc	Secondary current on short-circuit
IP 21	Protected against rain and moisture. No access to dangerous parts.
	Caution! Read the user manual before use
	Separate collection required – Do not throw in a domestic waste bin.
	Do not use in the open air. Do not use the product in damp/wet environments. IP21.
	Risk of interference and disturbance of electronic medical devices (i.e. pace-makers) when near of the product.
	Caution! Strong magnetic field. People wearing active or passive implants must be informed.
	Always wear suitable protective clothing to shield eyes, hands, and skin, when welding.

10 – DECLARATION OF CONFORMITY

GYS confirm that the product described within this manual conforms to the following directives:

- Low Voltage Directive 2006/95/CE in respect of the harmonized norm EN 62135-1
- Electromagnetic Compatibility Directive EMC 2004/108/CE in respect of the harmonized norm EN62135-2
- Machine Directive 2006/42/EC in respect of the harmonized norm EN 60204-1

11 - WARRANTY

- 1) The warranty is valid for one year only when the certificate of warranty has been filled correctly by the seller.
- 2) The warranty covers every default for one year, as from the purchase date (spare parts and labour).
- 3) THE WARRANTY DOESN'T COVER THE VOLTAGE ERRORS, damage due to a bad use, dropped product, dismantling or any issue due to mishandling during transport.
- 4) The warranty doesn't cover the normal wear and tear of the spare parts (e.g.: cables, clamps, etc.).

In case of breakdown, please return the unit to the GYS factory GYS with:

- the following certificate of warranty filled out by the seller and
- an explicative note of the breakdown.

After the warranty, our After-sales service provides the repairs after acceptance of the quotation.

ATTENTION

We remind you that we do not accept any product return with carriage cost not included.

SOCIETE GYS « S.A.V » : 134 Bd des Loges - BP 4159
 53941 SAINT-BERTHEVIN cedex
 FAX S.A.V : 02 43 01 23 75

CERTIFICATE OF WARRANTY

Seller stamp: _____

Reference of the unit:.....

Purchase date:.....

Seller Name Company:

Valid for one year as from the purchase

12 – CIRCUIT DIAGRAM

100RCX :

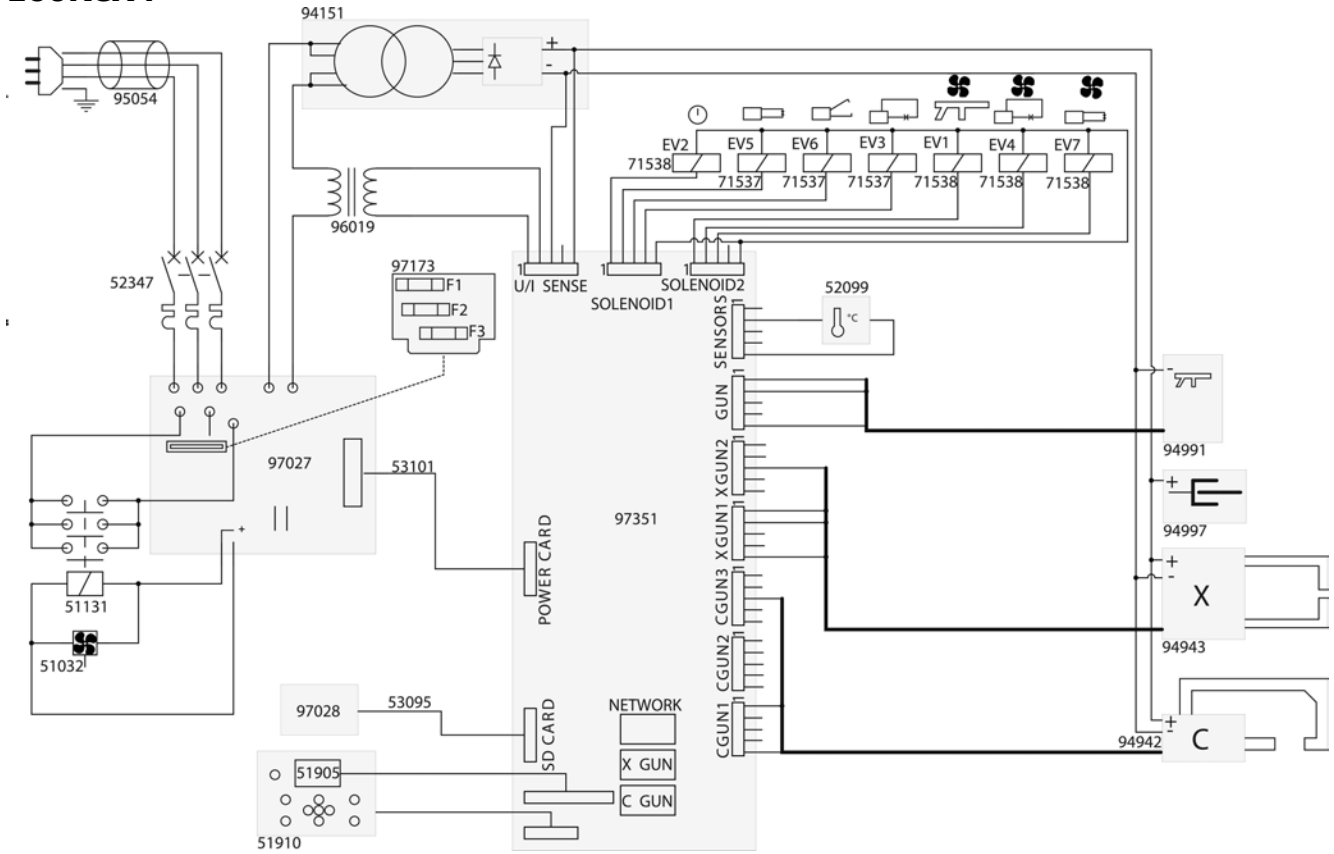

100RC :

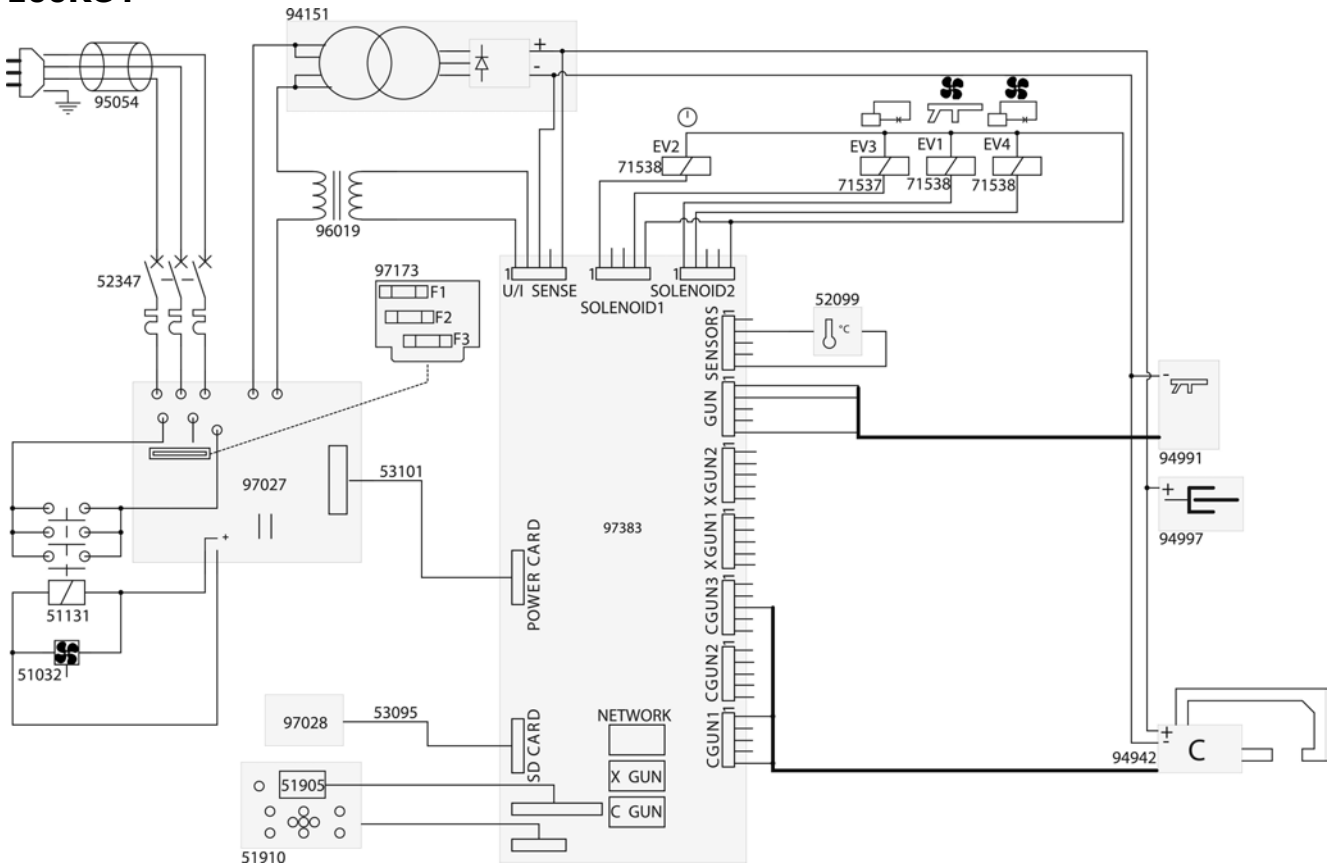

100 RX :

